

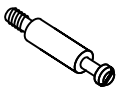













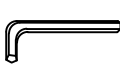

ASSEMBLY INSTRUCTIONS

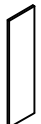
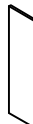
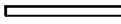
MODEL: PL156

Before assembly, please remove all parts from carton, verifying that you have the correct quantities, and read all the instructions.

IN THE CARTON:

1  Cam Lock 14 Pcs	2  Klix Cam 14 Pcs	3  Housing Cap 14 Pcs	4  Adjustable Glide 4 Pcs	5  Center Shelf Pin 4 Sets	6  Shelf Support Pin 16 Pcs	7  6 Hole L-Bracket 1 Pc	
		8  Screw #6 x 3/8" 6 Pcs	9  M4 x 65 Allen-Key 1 Pc	10  Pan Head Screw #8 x 32mm 4 Pcs			
A  Back Panel	B  Left Gable	C  Right Gable	D  Kick Plate	E  Top Panel	F  Bottom Panel	G  Fixed Shelf	H  Adj. Shelf x 4
				I  SIDE SUPPORT BOTTOM RAIL x2			

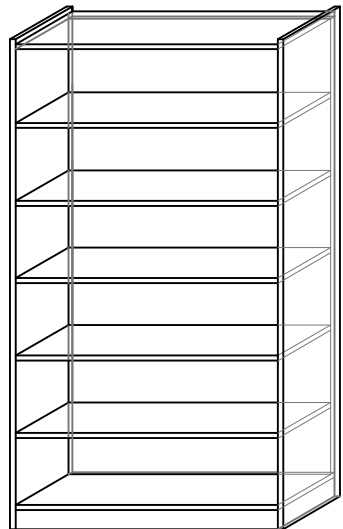

KLIX CAM INSTRUCTIONS

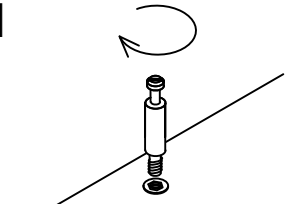
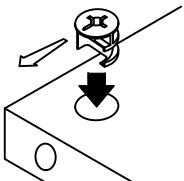
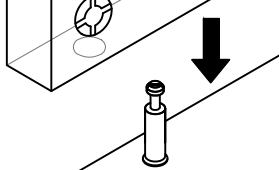
1  Line up Cam Lock, turn clockwise.	2  Insert the cam with the arrow pointing towards the hole in the edge.	3  Insert the Cam Lock into Klix Cam. Turn Klix Cam to lock.
---	---	---

Before assembly, please remove all parts from carton, verifying that you have the correct quantities, and read all the instructions.

IN THE CARTON:

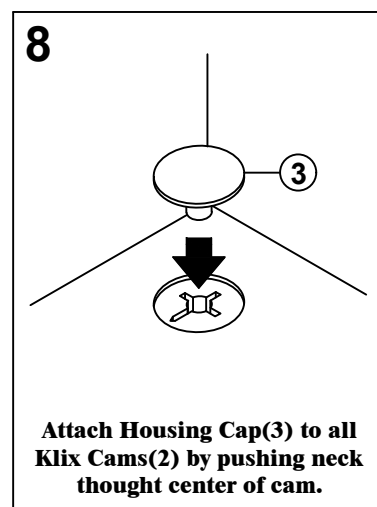
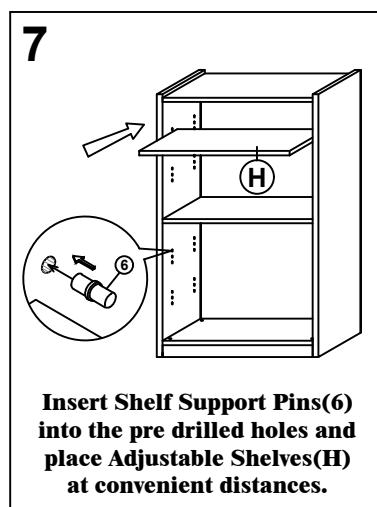
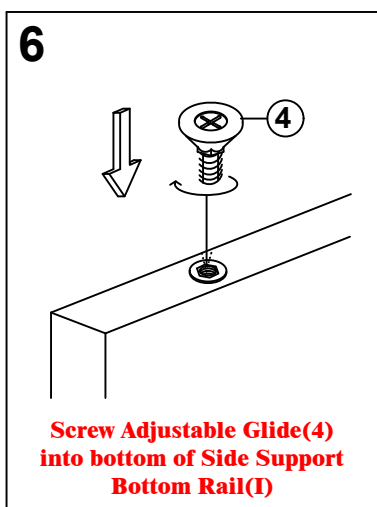
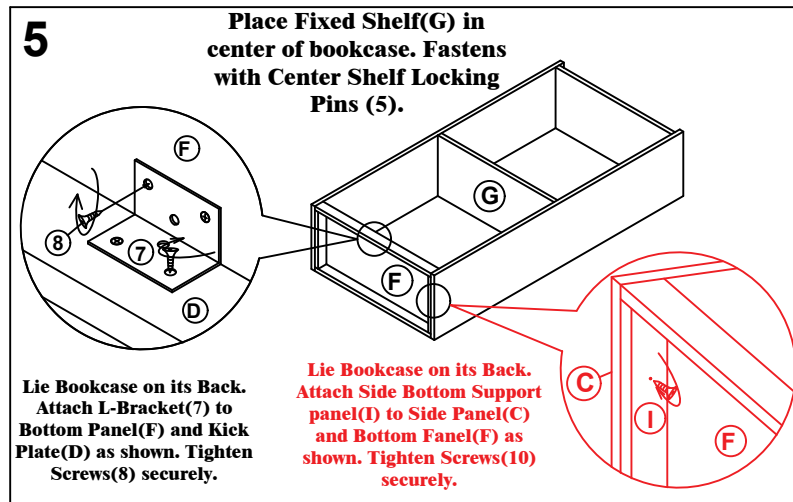
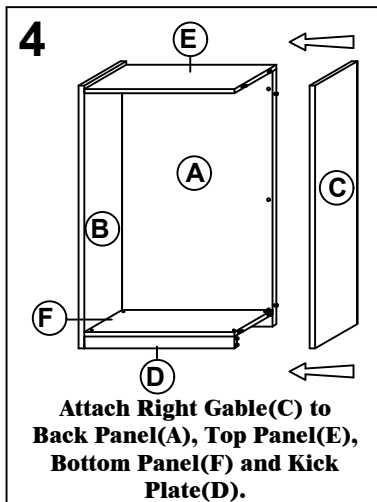
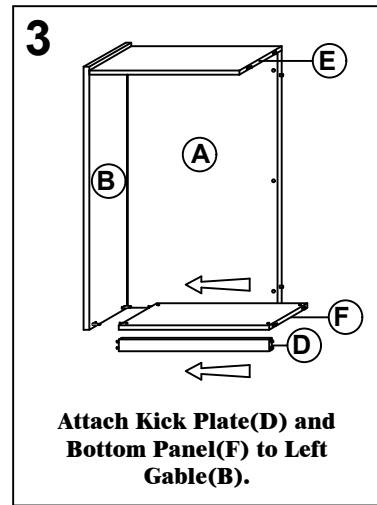
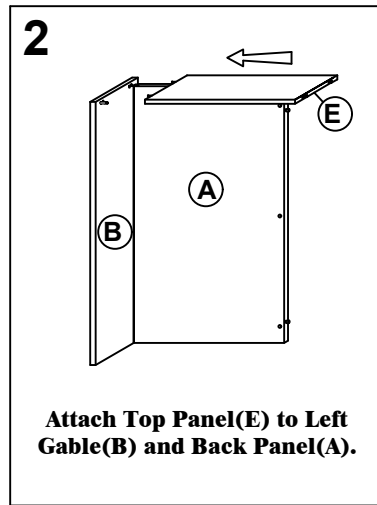
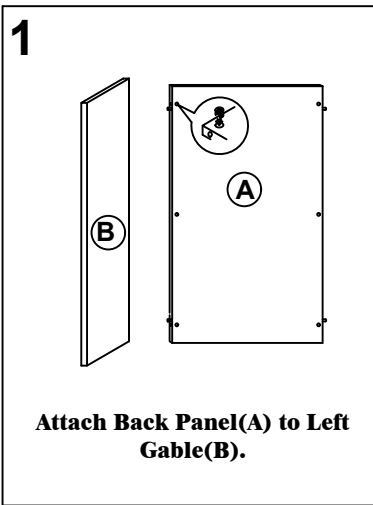

⚠ ATTENTION ⚠

Place all wooden parts on a clean, smooth surface to prevent them from being scratched. Check to be sure that you have all parts and hardware. Remove all wrapping materials, including staples and packing straps before you start to assemble. Do not tighten all screws/bolts until all completely assembled. Keep all hardware parts out of reach of children. If any parts are missing, broken, damaged or worn, stop use of product until repairs have been made using factory authorized parts. Failure to follow these warnings may result in injury.